



LAMILUX Flat Roof Access Hatch Comfort

230V Swing/Square - Operating instructions

CONTENTS

1. General information	4 - 7
1.1 Information on these operating instructions	
1.2 Instructions for use	
1.3 Explanation of symbols	
1.4 Warnings	
1.5 Limitations of Liability	
1.6 Copyright protection	
1.7 Spare parts	
1.8 Customer service	
1.9 Manufacturer's address	
2. Safety	8 - 13
2.1 General information	
2.2 Responsibility during installation and operation	
2.3 Personnel requirements	
2.3.1 Qualification of personnel	
2.3.2 Unauthorised persons	
2.3.3 Instruction	
2.4 Intended use	
2.5 Delimitation of the danger zone	
2.6 Special hazards	
2.6.1 Electrical	
2.6.2 Mechanical	
2.7 Risk of falling	
2.8 Personal protection equipment	
2.9 Safety equipment	
2.10 Signage on the roof access hatch	
3. Technical data	14 - 16
3.1 Data sheet	
3.2 Dimension sheet	
3.3 Type plate	
3.4 Environmental conditions	
4. Transport, installation and connection	16 - 24
4.1 Safety	
4.2 Transport	

4.2.1 Transport inspection	
4.2.2 Packaging/storage	
4.2.3 Transport variants	
4.3 Installation	
4.3.1 Preparation	
4.3.2 Installation	
4.3.3 Connection	
5. Description	25
5.1 Functional description	
5.2 Operating elements	
6. Operation	26 - 29
6.1 Safety	
6.2 Commissioning	
6.3 Operation	
7. Maintenance	30 - 33
7.1 Safety	
7.2 Maintenance	
7.3 Repairs	
7.4 Cleaning	
8. Troubleshooting	34 - 35
8.1 Safety	
8.2 Malfunctions and troubleshooting	
9. Dismantling and disposal	36 - 37
9.1 Safety	
9.2 Dismantling	
9.3 Disposal	
10. Commissioning protocol	38 - 39
11. Declaration of conformity	40 - 41
12. Notes	42 - 43

1. GENERAL INFORMATION

1.1 Information on these operating instructions

These operating instructions enable the safe and efficient use of the "LAMILUX Flat Roof Access Hatch Comfort Swing/Square", hereinafter referred to as the roof access hatch.

The operating instructions are an integral part of the roof access hatch and must be kept in the immediate vicinity of the roof access hatch and accessible to the personnel/operator at all times. The personnel/operator must have carefully read and understood the operating instructions before starting any work.

The basic prerequisite for safe working is compliance with all the safety and handling instructions in this operating manual.

In addition, the local accident prevention regulations and general safety regulations for the area of use of the roof access hatch apply.

Illustrations in these operating instructions are for basic understanding and may differ from the actual design of the roof hatch.

1.2 Instructions for use

The pages of the operating instructions are numbered consecutively.

To make it easier to find a section, a table of contents is provided behind the cover page of the operating instructions.







If the operating instructions contain basic or further information on a topic elsewhere, the user of the operating instructions is referred to this by cross-references. All illustrations and drawings in these operating instructions are for general illustration purposes and are not necessarily to scale for better

representation of the facts. They may differ slightly from the actual design of the roof access hatch.

1.3 Explanation of symbols

Warnings are also indicated in the operating instructions by warning symbols.

The following warning symbols are used in these operating instructions.

Symbols	Meaning
	General warning
	Danger due to electric current
	Crushing hazard
	Danger from suspended loads
	Risk of falling
	Danger of environmental pollution

Symbols	Meaning
	Do not enter! Climbing prohibited!
i	Information text ...

1.4 Warnings

The warnings used in these operating instructions are introduced by signal words that express the extent of the hazard.

The warning symbol also indicates the type of hazard.

The following warnings are used in these operating instructions:

Danger	
	<p>Danger to life!</p> <p>Consequences of non-observance ...</p> <p>>> Notes on avoidance</p>

A warning of this danger level indicates an imminently dangerous situation.

If the dangerous situation is not avoided, this will result in death or serious injury.

Follow the instructions in this warning to avoid the risk of death or serious injury to persons.

Warning	
	<p>Risk of injury!</p> <p>Consequences of non-observance ...</p> <p>>> Notes on avoidance</p>

A warning of this hazard level indicates a potentially dangerous situation.

If the dangerous situation is not avoided, this can

lead to death or serious injury.

Follow the instructions in this warning to avoid the possible risk of death or serious injury to persons.

Caution	
	<p>Personal injury due to ...</p> <p>Consequences of non-compliance ...</p> <p>>> Notes on avoidance</p>

A warning of this hazard level indicates a potentially dangerous situation.

If the dangerous situation is not avoided, this may result in minor or moderate injuries.

Follow the instructions in this warning to avoid personal injury.

Attention	
	<p>Material damage due to ...</p> <p>Consequences of non-compliance ...</p> <p>>> Notes on avoidance</p>

A warning of this hazard level indicates possible damage to property.

If the situation is not avoided, property damage may occur.

Follow the instructions in this warning to avoid damage to property.

Note	
i	Note text ...

A note indicates additional information that is important for further processing or facilitates the described work step.

1.5 Limitations of liability

All information and instructions in these operating instructions have been compiled taking into account the applicable standards and regulations, the state of the art and our many years of knowledge and experience.

We reserve the right to make technical changes as part of the further development of the roof access hatch described in these operating instructions.

No claims can be derived from the information, illustrations and descriptions in these operating instructions.

The manufacturer accepts no liability for damage and malfunctions due to:

- Non-compliance with these operating instructions,
- improper use,
- use by untrained or insufficiently trained personnel,
- use of unauthorised equipment,
- incorrect connection,
- preliminary work that is not part of the scope of delivery and services,
- non-use of original spare parts and accessories,
- technical modifications and conversions, if these have not been agreed with LAMILUX Heinrich Strunz GmbH.
- failure to carry out prescribed maintenance work,
- execution of welding work on the roof access hatch.

LAMILUX Heinrich Strunz GmbH shall be liable for any errors or omissions on our part, with the exclusion of further claims, within the scope of the warranty obligations entered into in the contract. Claims for damages, regardless of the legal grounds on which they are based, are excluded.

	Note
i	The operator of the LAMILUX Comfort Swing/Square flat roof access hatch is recommended to conclude a maintenance contract with LAMILUX Heinrich Strunz GmbH. This ensures that the roof access hatch is regularly inspected by our service personnel and that necessary wear and spare parts are available without long delivery times.

1.6 Copyright protection

All documents are protected under copyright law. Passing on and reproduction of documents, even in part, and utilisation of their contents are not permitted unless expressly authorised. Infringements are punishable by law and will result in compensation for damages.

We reserve all rights to exercise industrial property rights.

1.7 Spare parts

	Warning
	Risk of injury! Incorrect or faulty spare parts can lead to damage, malfunctions or total failure of the machine and endanger safety. >> Use original spare parts from the manufacturer only.

1.8 Customer service

If you have any technical questions about the LAMILUX flat roof exit Comfort Swing/Square, please contact the customer service department of LAMILUX Heinrich Strunz GmbH.

In this case, please provide the following information:

- Flat Roof Access Hatch Comfort Swing/Square
- Year of construction
- Product no.

The required information can be found on the type plate of the LAMILUX Flat Roof Access Hatch Comfort Swing/Square.

1.9 Manufacturer's address

LAMILUX Heinrich Strunz GmbH
Zehstraße 2
95111 Rehau

P.O. Box 1540

Phone: +49 (0) 9283 / 595-0

Fax.: +49 (0) 9283 / 595-290

Mail: information@lamilux.de

www.lamilux.de

2. SAFETY

2.1 General information

This chapter provides important information on all safety aspects for optimum protection against hazards during installation and safe and trouble-free operation.

Warning	
	<p>Danger in case of non-observance of the safety instructions!</p> <p>Failure to observe the safety information and handling instructions listed in these operating instructions can result in considerable danger.</p> <p>>> Always observe the warnings and instructions described in this manual.</p>

2.2 Responsibility during installation and operation

When installing the roof hatch, the company carrying out the work is subject to the statutory obligations regarding health and safety at work.

In addition to the occupational safety instructions in these operating instructions, the safety, accident prevention and environmental protection regulations applicable to the installation and operation of the LAMILUX Comfort Swing/Quadrat flat roof access hatch must be observed.

Observe the following points:

- Inform about the applicable health and safety regulations and carry out a risk assessment to identify additional hazards arising from the special working conditions at the installation site of the roof access hatch. These must be implemented in the form of work instructions for the installation and operation of the roof hatch.
- Secure danger points that arise due to the installation of the roof access hatch (e.g. proximity to the edge etc.).
- Check during the entire installation and operating time of the roof access hatch whether the operating instructions created correspond to the current status of the regulations and adapt them if necessary.
- Clearly define and regulate the responsibilities of personnel for installation, operation, maintenance and cleaning.
- Ensure that everyone who works with the roof access hatch has read and understood the operating instructions. In addition, personnel must be trained at regular intervals and be informed about dangers.
- Ensure safe and hazard-conscious handling of the roof access hatch in accordance with the operating instructions.
- Make the operating instructions and all other documents accessible to personnel at all times.
- Provide personnel with the necessary protection equipment.

Furthermore, the operator is responsible for ensuring, that the roof access hatch is always in perfect condition.

To do this, the operator must ...

- ensure that the cleaning and maintenance intervals specified in these operating instructions are observed.
- have all safety equipment checked regularly for proper functioning and completeness.

2.3 Personnel requirements

2.3.1 Qualification of personell

Warning	
	<p>Risk of injury due to inadequate qualification!</p> <p>Risk of injury due to inadequate qualification!</p> <p>Improper handling can lead to considerable personal injury and property damage.</p> <p>>> All work must only be carried out by qualified personnel only.</p>

These operating instructions specify the following qualifications for various fields of activity:

- Instructed person
has been instructed by the operator about the work assigned to them and the possible dangers of improper behaviour.
- Qualified personnel
is able to carry out the work assigned to him/her and recognise and avoid possible dangers due to his/her technical training, knowledge and experience as well as knowledge of the relevant regulations.
- Qualified electrician
is able to carry out work on electrical systems and independently recognise and avoid potential hazards due to his/her professional

training, knowledge and experience as well as knowledge of the relevant standards and regulations.

The qualified electrician is trained for the specific location where they are working and is familiar with the relevant local standards and regulations.

Only persons who can be expected to carry out their work reliably are authorised as personnel. Persons whose ability to react is impaired, e.g. by drugs, alcohol or medication, are not authorised.

Personnel to be trained, instructed or undergoing general training may only be assigned assembly and operating tasks under the constant supervision of an experienced person!

Note	
	<p>When selecting personnel, observe the age and occupation-specific regulations applicable at the installation and work site.</p>

2.3.2 Unauthorized persons

Warning	
	<p>Danger for and from unauthorised persons!</p> <p>Unauthorised persons who do not meet the requirements described are not aware of the dangers in the work area.</p> <p>>> Keep unauthorised persons away from the work area.</p> <p>>> If in doubt, speak to people and direct them away from the work area.</p> <p>>> Stop work as long as unauthorised persons are in the work area.</p>

2.3.3 Instruction

Installation personnel and operators must be instructed regularly by the responsible person (site manager, operator, etc.).

Note	
i	For better tracking, record the execution of the instructions and have the participants sign a receipt.

2.4 Intended Use

The LAMILUX Flat Roof Access Hatch Comfort Swing/ Square is to be used as an exit opening on flat roofs. It can also be used for daily ventilation.

Opening and closing is always carried out via a control unit with enabling function, which must be positioned within sight of the element. Only the supplied control centre in combination with a key switch without hold-open function may be used as an operating element. Moreover, the roof access hatch must be the only means of access to the associated roof area (this ensures that no persons can enter the danger zone from outside unnoticed by the operator during operation). If there are several access options to the roof area, a risk assessment must be carried out for each case. This ensures that the roof access hatch can be operated safely.

Any other use or use beyond this is considered improper use.

Warning	
	<p>Danger due to improper use</p> <p>Any use of the LAMILUX Flat Roof Access Hatch Comfort Swing/Square that goes beyond and/or differs from the intended use can lead to dangerous situations.</p> <p>>> Only use the LAMILUX Flat Roof Access Hatch Comfort Swing/Square as intended.</p> <p>>> Observe all instructions in these operating instructions.</p>

Claims of any kind due to damage resulting from improper use are excluded.

The risk is borne solely by the operator.

2.5 Delimitation of the danger zone

The danger zone of the roof exit consists of the following areas with an additional safety distance of 500 mm to each side:

- G1: Area vertical below the ceiling opening
- G2: Main and secondary closing edge of the cover
- G3: Roof area below the traverse range of the sash (closed to maximum opening angle)

Fall protection measures (e.g. railings) must be installed on the opener side and opposite the entry/exit side.

The safety distances of DIN EN 349 to fixed roof structures (railings, walls) must be observed.

Depending on the staircase used for access, a handrail is recommended in the exit area.

2.6 Special hazards

2.6.1 Electrical

Danger	
	<p>Danger from electric current!</p> <p>Contact with live cables or components can be fatal!</p> <p>>> Work on electrical equipment may only be carried out by a qualified electrician or by instructed persons under the direction and supervision of a qualified electrician in accordance with the electro-technical regulations.</p> <p>>> Any defects found in electrical systems/assemblies/equipment must be rectified immediately. If there is an acute danger until then, the system, assembly or equipment may not be used in the defective condition.</p> <p>>> Parts on which inspection, maintenance and repair work is carried out must - if specified - be disconnected from the power supply and secured against being switched on again. First check that the disconnected parts are voltage-free, then earth and short-circuit them and insulate neighbouring live parts!</p>

Danger	
	<p>>> If it is necessary to work on live parts, call in a second person to operate the main switch with voltage release in an emergency. Block off the work area with a red and white safety chain and a warning sign. Only use voltage-insulated tools!</p> <p>>> Fuses must not be repaired or bypassed. Only use original fuses with the specified currents!</p>

2.6.2 Mechanical

Warning	
	<p>Risk of crushing!</p> <p>There is a risk of injury when opening and closing the roof access hatch.</p> <p>>> Do not stand in the danger zone when opening and closing the device</p> <p>>> Do not reach into the moving parts.</p> <p>>> Do not disable the sensor</p>



2.7 Risk of falling

Warning	
	<p>Risk of falling!</p> <p>There is a considerable risk of injury or even death from falling at the roof access hatch and roof edges.</p> <p>>> Do not step on the edges</p> <p>>> Block off danger zones</p> <p>>> Wear personal protection equipment</p>

2.8 Personal protection equipment

Warning	
	<p>Risk of injury due to incorrect or missing protection equipment!</p> <p>Personal protection equipment must be worn at work to minimise health hazards.</p> <p>>> Always wear the protection equipment required for the respective work during work.</p> <p>>> Follow the instructions on personal protection equipment in the work area.</p>

The following protection equipment must be worn for all work on the roof access hatch:

	<p>Safety helmet to protect the head from falling objects or impact to the head</p>
	<p>Safety footwear with steel toe cap</p>

Special protection equipment is also required when carrying out particular jobs. This is referred to separately in the individual chapters. Wear the following additional protection equipment when carrying out particular work on the roof access hatch:

	<p>Work gloves to protect against injuries</p>
---	--

	<p>Harness for fall protection</p>
---	------------------------------------

2.9 Safety equipment

Warning	
	<p>Danger due to missing/non-functioning safety equipment!</p> <p>Missing or non-functioning safety equipment can cause extremely serious injuries.</p> <p>>> Only operate the roof access hatch if all safety equipment is available and functional.</p>

The LAMILUX Comfort Swing/Square flat roof access hatch was manufactured in accordance with the legal requirements applicable in the European Union.

The provisions of standard DIN EN 12978 "Doors and gates - Safety devices for power-operated doors and gates" have been complied with. Nevertheless, the roof hatch can present hazards if it is operated improperly or not in proper condition. Danger points that cannot be excluded by design are identified by warning signs on the roof hatch and work safety instructions in the operating instructions.

2.10 Signage on the roof access hatch

	Note
i	Warning/danger signs are attached to the roof access hatch to protect the installation and operating personnel. Observe these signs. Damaged or illegible warning/danger signs must be replaced immediately.

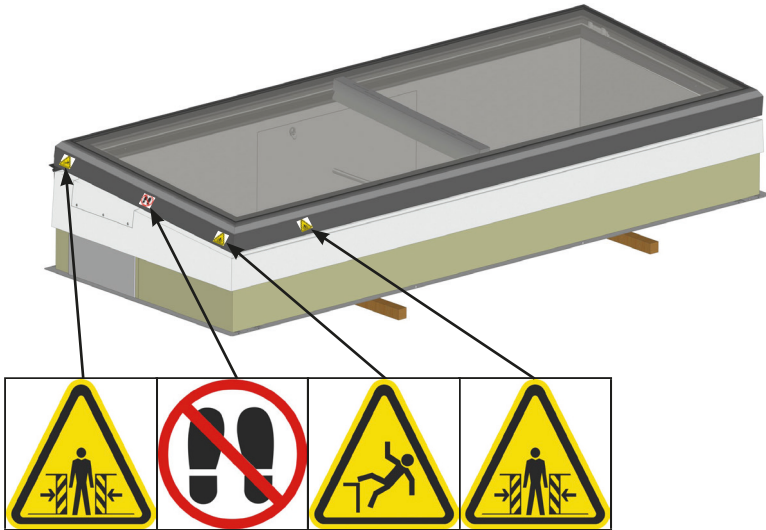

3. TECHNICAL DATA

3.1 Data sheet

Type	LAMILUX Flat Roof Access Hatch Comfort Swing	LAMILUX Flat Roof Access Hatch Comfort Square	
Length OKD	3000 / 3500	2000	mm
Width OKD	1000	2000	mm
Length	3324 / 3824	2324	mm
Width 1	1324	2324	mm
Width 2	1606	2606	mm
Height (without accessories)	606	797	mm
Weight (without transport pallet)	approx. 515	approx. 515	kg
Electrical system			
Connected load	max. 1,36 1-phase	max. 1,36 1-phase	kW
Power consumption	5,9	5,9	A
Mains voltage	230	230	V _{AC}
Mains frequency	50	50	Hz
Control voltage	24	24	V _{DC}

3.2 Dimension sheet

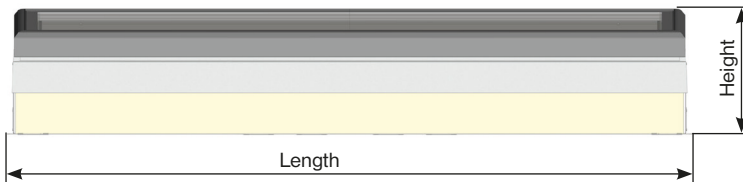
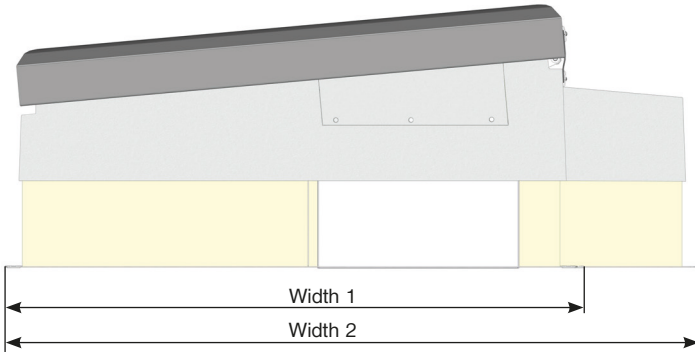

4. TRANSPORT, INSTALLATION AND CONNECTION

3.3 Type plate

The type plate is located on the frame profile (inside).

The following information is on the type plate:

- Function
- Type/model
- Serial no.
- Year of manufacture

3.4 Environmental conditions

Temperature range	-30 bis +70	°C
Wind load	1500	N/m ²
Snow load	750	N/m ²
Permissible operating snow load	500	N/m ²
Wind resistance class (open)	Class 3, 38-49 km/h	

4.1 Safety

Warning	
	<p>Risk of injury!</p> <p>When lifting loads, there is a risk of injury or even death from falling or uncontrolled swivelling parts.</p> <p>>> Never stand under suspended loads.</p> <p>>> Observe the information on the attachment points provided.</p> <p>>> Do not attach to protruding parts of the roof access hatch. Ensure that the lifting gear is securely attached.</p> <p>>> Only use approved lifting gear and attachment equipment with sufficient load-bearing capacity.</p> <p>>> Do not use damaged ropes and/or straps.</p> <p>>> Do not attach ropes and straps to sharp edges and corners, do not knot or twist them.</p>

Warning	
	<p>Risk of falling!</p> <p>There is a considerable risk of injury or even death from falling at the roof access hatch and on the roof edges.</p> <p>>> Do not step on the roof edges</p>

Warning	
	>> Block off danger zones >> Wear personal protection equipment

Warning	
	<p>Risk of injury due to incorrect or missing protection equipment!</p> <p>Risk of injury due to incorrect or missing protection equipment!</p> <p>Personal protection equipment must be worn at work in order to minimise health hazards.</p> <p>>> Always wear the protection equipment required for the respective work during work.</p> <p>>> Follow the instructions on personal protection equipment displayed in the work area.</p>

Warning	
	<p>Risk of injury due to insufficient qualification!</p> <p>During installation and maintenance, there is a risk of injury to the person carrying out the work due to working in the danger zone. Incorrect installation or maintenance can result in dangers for subsequent operation.</p> <p>>> Assembly and maintenance work may only be carried out by qualified personnel.</p>

4.2 Transport

Attention	
	<p>Damage due to improper transport!</p> <p>Improper transport can cause considerable material damage.</p> <p>>> When unloading the packages on delivery and during internal transport, proceed with caution and observe the symbols and instructions on the packaging.</p> <p>>> Do not remove the packaging until shortly before installation.</p> <p>>> Never place the roof access hatch directly on the ground! Place squared timber underneath to avoid shearing the electrical cables.</p> <p>>> Do not expose the roof access hatch to the weather (moisture) when it is not installed.</p>

4.2.1 Transport inspection

Check the delivery immediately upon receipt for completeness and transport damage.

Note	
	<p>Failure to comply with the following instructions in case of a claim may invalidate the insurer's obligation to pay benefits.</p>

Proceed as follows in case of externally recognisable transport damage:

- Even in case of suspected damage only acknowledge receipt with reservations (e.g. on

the freight document) stating the suspected damage.

- In the case of goods in containers, ensure that containers and locks or seals are checked by responsible persons of the shipping company or the carrier. If containers are damaged or locks and seals are broken, missing or deviate from the freight documents, only certify receipt with details of the suspected damage and retain damaged or incorrect locks and seals.
- Ensure claims for compensation against third parties.

Shipping company, other carriers, freight forwarders, warehouse keepers, customs and port authorities

- request a joint damage survey,
- request certification of the damage
- make them liable in writing and
- describe the damage in detail

In the case of externally recognisable damage before acceptance of the goods, in the case of externally unrecognisable damage immediately after discovery.

- Determine and comply with complaint deadlines

	Note
i	Complain about any defect as soon as it is recognised. Claims for damages can only be filed within the applicable complaint periods.

- Ensure that any damage incurred is minimised and further damage is averted.
- Immediately call in the average adjuster named in the insurance documents, who will assess the damage and provide advice on securing compensation claims against third parties and on measures to minimise the damage.
- Do not change the condition of the consign-

ment and its packaging until the arrival of the average adjuster, unless this is necessary to minimise and avert further damage.

- Immediately notify the insurer of the insured case and, in order to expedite claims settlement, provide the insurer with complete claims documentation as soon as possible (but at the latest in good time before the expiry of any exclusion and/or limitation periods for claims for compensation against third parties).

4.2.2 Packaging/storage

The roof access hatch is mostly pre-assembled at the factory and packaged accordingly.

- Leave the roof access hatch in its packaging until installation.
- Store the roof access hatch covered in a dry place.

4.2.3 Transport variants

For safe transport, the roof hatch must remain on the transport pallet and be transported on it until it is installed on the roof. It can be transported with a forklift or by crane.

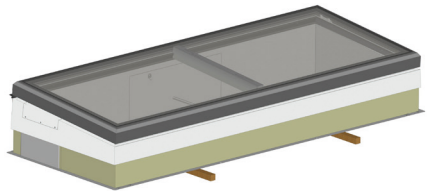

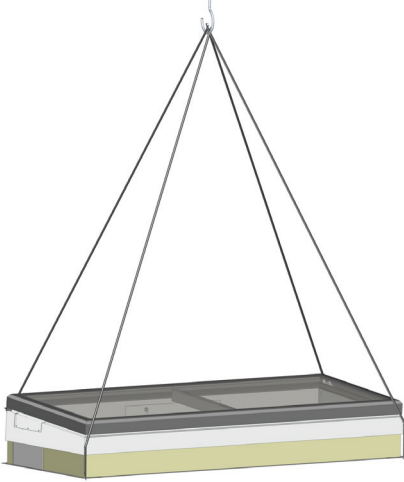

It can also be transported using the fastening eyelets on the frame. (The illustration shows the Comfort Swing version. Transport of the Comfort Square is similar.)

4.3 Installation

Note: The installation is described in detail in the separate installation instructions.

Only the fixing materials listed in the installation instructions are authorised for installation. Installation, connection and commissioning may only be carried out by qualified personnel. After installation of the roof access hatch, initial commissioning must be carried out by a competent person in accordance with the safety inspection. The roof access hatch may only be installed with the safety distances specified in DIN EN 349. That means that the following safety distances must be maintained at the maximum projection (corresponding to the open roof access hatch):

- Minimum distance to fixed parts on the roof: 300mm
- With a hull hazard: 500mm

Depending on the construction and the design on the roof, a corresponding step must be installed.

Warning	
	<p>Risk of falling!</p> <p>There is a considerable risk of injury or even death from falling at the roof access hatch and roof edges.</p> <p>>> Do not step on the edges</p> <p>>> Block off danger points</p> <p>>> Wear personal protection equipment</p>

If normal ambient light does not sufficiently illuminate the danger zone, additional lighting must be installed on site.

4.3.1 Preparation

Before starting work, a risk analysis must be carried out to systematically check how the national occupational health and safety regulations and the accident prevention regulations of the employers' liability insurance associations can be complied with.

In the course of the risk assessment, it must also be checked which risks may arise from the function of the roof access hatch in connection with the installation site and which technical or organisational measures may need to be taken. There is a risk of shearing and crushing when operating the roof access hatch.

Transport and storage at the installation site

Bring the roof access hatch onto the roof using suitable aids (lifting gear, etc.) (see chapter "Transport")

Roof opening

Structure for Flat Roof Access Hatch Comfort Swing - opening direction left:

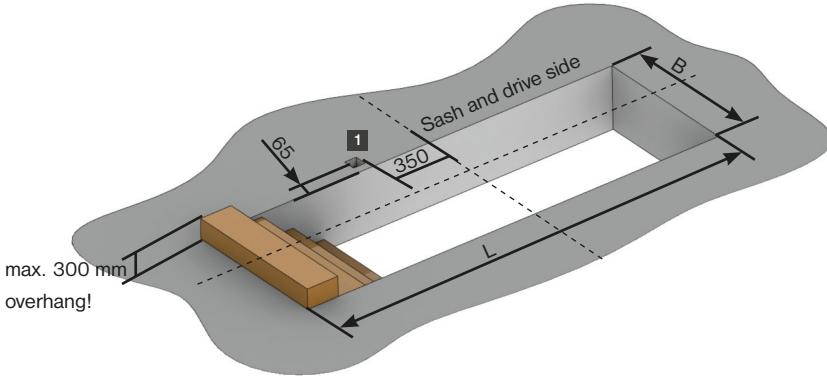

Create the roof opening as specified (see sketch above).

Structure for Flat Roof Access Hatch Comfort Swing - opening direction right:

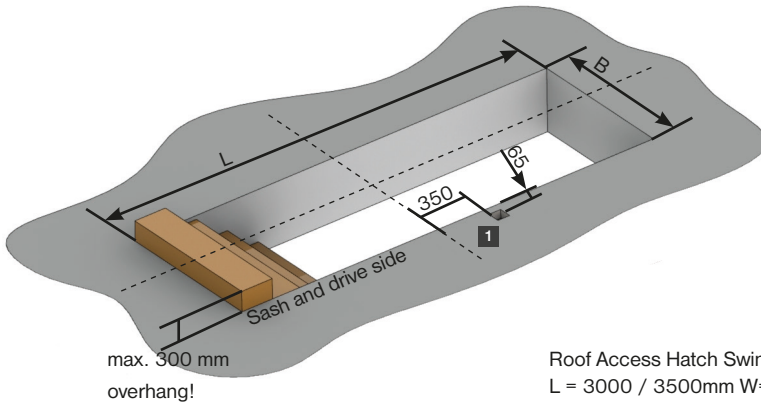

Roof Access Hatch Swing:
L = 3000 / 3500mm W= 1000mm
1 = Cut-outs for connection cable or terminal box

Create the roof opening as specified (see sketch above)

Structure for Flat Roof Access Hatch Comfort Square:

The base of the upstand element must be horizontal all the way round!

The pre-mounted limit switch in the Flat Roof Access Hatch Square is always on the side of the stairs.

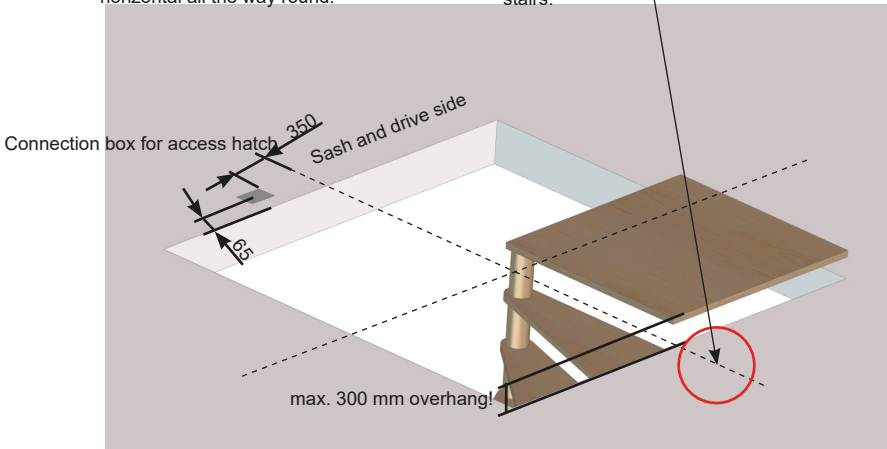

Prepare the roof opening as specified (see sketch above)

Attention	
	<p>Damage due to improper storage at the installation site!</p> <p>Improper storage at the installation site can cause considerable material damage.</p> <p>>> Proceed with caution when unloading the packages on delivery and during internal transportation and observe the symbols and instructions on the packaging.</p> <p>>> Do not remove the packaging until shortly before installation.</p> <p>>> Never place the roof access hatch directly on the ground! Place squared timber underneath to prevent the electrical cables from shearing off.</p> <p>>> Do not expose the roof access hatch to the weather (moisture) when not installed.</p> <p>>> Store the roof access hatch well ventilated and avoid heat build-up.</p> <p>>> Do not lift the roof hatch with glass suction cups.</p>

The pre-assembled limit switch in the roof access hatch is always on the opposite side of the staircase.

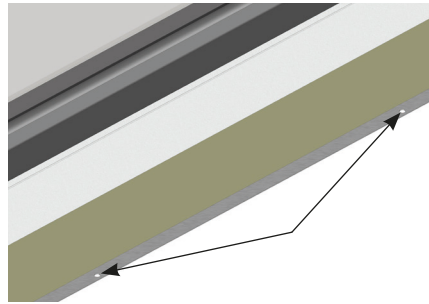

The holes for the fasteners are already present in the construction of the roof access hatch. Suitable fasteners must be selected for the existing substrate and used to fix the roof access hatch. A list of fasteners can be found in the separate installation instructions.

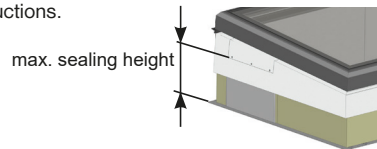

The maximum sealing heights of 300 mm (for Roof Access Hatch Swing) or 340 mm (for Roof Access Hatch Square) must not be exceeded. This is the only way to ensure unhindered access to the inspection opening.

4.3.2 Installation

Place the roof access hatch on the roof opening. Route the connection cables from the unit casing down through the opening in the frame into the roof junction box. Avoid cutting the cables.

The base of the upstand element must be horizontal all round. Before attaching the roof extension, check whether the sash seal between the upstand element and the sash is in contact all the way around. If this is not the case, the misalignment must be corrected by lining the roof access hatch opening on the support. A later correction is not possible!

4.3.3 Connection

Danger	
	<p>Danger from electric current!</p> <p>Contact with live cables or components poses a danger to life!</p>

Danger	
	<p>>> Work on electrical equipment may only be carried out by a qualified electrician or by instructed persons under the direction and supervision of a qualified electrician in accordance with the electro-technical regulations.</p> <p>>> Before starting work, the safety rules of electrical engineering must be observed and applied.</p>

Warning	
	<p>>> Only push-buttons without self-holding are permitted as operating devices for the control unit. Switches or any controls that lead to automated operation (e.g. thermostats, wind/rain sensor controls) are not permitted.</p> <p>>> Install the operating device within sight of the roof access hatch</p>

Warning	
	<p>Risk of injury due to improper installation!</p> <p>Only carry out connection work on the supplied control unit in accordance with the enclosed terminal scheme. Modifications to the circuit and control unit can lead to serious personal injury or damage to property.</p> <p>>> Under no circumstances may the roof hatches perform automatic movements due to the type of control or an additional control system. (Opening via the emergency button in the case of danger is an exception).</p> <p>>> The roof access hatches may only be connected and operated with the sensor integrated in the control unit.</p> <p>>> Never connect drives directly to the supply voltage without a control unit.</p>

- The key switch must be installed on the staircase level within sight of the roof hatch.
- Only ONE key switch is permitted to operate the roof access hatch.
- The roof access hatch is operated with 230V AC.
- Install the terminal box to connect the supply cable of the roof access hatch with the power supply and the key switch on the ceiling connection of the roof access hatch.

Note	
	<p>To ensure authorized operation of the roof hatch, a key switch without automatic hold-open must be used.</p>

Attention	
	<p>Malfunctions!</p> <p>Changing the connection cables to the drives can lead to malfunctions or even total failure of the roof access hatch.</p> <p>>> Connect the connecting cables of the drives in a terminal box provided by the customer without changing the supply cables (shortening/ extending).</p>

- Connect the roof access hatch according to the terminal diagram.
- The connections of the wind and rain sensor for awnings can be found in the manufacturer's separate instructions
- The batteries must be screwed on and put into operation as described in the installation instructions

Note	
	<p>Design the power supply for the roof access hatch as a separate circuit.</p>

The following fuses are installed in the roof access hatch control:

- Circuit breaker B10 for 230 VAC power supply (designation F1)
- Safety fuse for valve control and control lines 24 VDC 2.5A slow-blow (designation F2)

Fuse to be fitted on site: RCD (residual current device) with 30mA to be implemented in accordance with current standards.

Note	
	<p>It is NOT permitted to operate the roof access hatch with automatic controls (e.g. smart home controls, wind and rain sensors, etc.).</p>

Limit switch:

The limit switch signals to the control unit when the sash is flush with the frame.

The limit switch is pre-assembled and is located on the inside of the frame, on the narrow side opposite the staircase. Before initial operation, check that the limit switch is set correctly and that the sash is flush with the substructure. If this is not the case, the limit switch must be readjusted. To do this, move the housing of the switch up or down until the limit switch is triggered or pressed by the sash.

If the limit switch is not set correctly, leaks or material damage to the substructure may occur.

Attention	
	<p>Warning of material damage!</p> <p>Failure to check and adjust the limit switch may result in material damage to the structure or the operator's property.</p> <p>>> Before initial operation, check that the sash is flush with the substructure and the limit switch is triggered as a result.</p>

5. DESCRIPTION

5.1 Functional description

The roof access hatch is designed as a system with a glass element as opening sash. The sash is driven by two synchronized lifting cylinders. The opening sash is folded upwards in a linear movement. It is controlled via the integrated control unit. The movement is triggered by a key switch fitted on site without self-holding, which must be operated by the operator with visual contact to the roof access hatch. In addition, the access opening is monitored by a sensor installed in the roof access hatch to prevent people from being endangered when climbing through. A pre-assembled awning with wind and rain sensor is available as an accessory. It is operated by means of a push-button.

5.2 Operating elements

The two lifting cylinders are connected to a unit in the inspection opening. The cylinders open and close the roof access hatch. The cylinders are synchronized by internal electronics. A separate synchronous control is not required. The two components of the light barrier are factory-fitted to the short sides of the roof access hatch. The receiver and transmitter of the sensor are mounted in alignment with each other. The sensor monitors the access area of the roof access hatch to prevent damage or danger to people in the opening sash's travel range. If the sensor is triggered, it stops the vehicle from moving or prevents it from moving off. The entire control of the roof access hatch is carried out via the associated control unit. The control unit is housed in an external casing. The control unit releases the movement or blocks it if the sensor is interrupted.

To operate the roof access hatch, a key switch without self-holding must be fitted on site. The roof access hatch may only be operated by trained personnel. The switch must be positioned so that the operator has direct visual contact with the roof access hatch, thus ensuring additional personal safety.

	Note
i	To ensure authorized operation of the roof access hatch, a key switch without self-hold must be used.

Operating elements during installation

After connecting the 230V operating voltage, the element can be opened and closed (without connecting the control line of the on-site key switch) using the key switch on the switch cabinet.

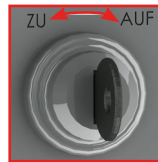



The switch cabinet is located behind the inspection cover. The light barrier is active! The monitoring area must not be disturbed.

6. OPERATION

6.1 Safety

Warning	
	<p>Danger of falling!</p> <p>There is a considerable risk of injury and even death from falling at the roof access hatch and the roof edges.</p> <p>>> Do not step on the edges. >> Block off danger points. >> Wear personal protection equipment.</p>

Warning	
	<p>Risk of crushing!</p> <p>There is a risk of injury when opening and closing the roof access hatch.</p> <p>>> Do not stand in the exit area when opening and closing the device. >> Do not reach into the moving parts.</p>

Warning	
	<p>Risk of injury!</p> <p>There is a risk of injury to third parties when opening and closing the roof access hatch.</p> <p>>> Only trained operators are permitted to operate the roof hatch. >> When opening and closing, maintain eye contact with the roof hatch to protect third parties from danger.</p>

Warning	
	<p>Risk of injury due to incorrect or missing protection equipment!</p> <p>Personal protection equipment must be worn at work in order to minimize health hazards.</p> <p>>> Always wear the protection equipment required for the respective work while working. >> Follow the instructions for personal protection equipment displayed in the work area.</p>

Note	
	<p>The system will not function in case of a power failure!</p> <p>In case of an approaching storm, close the roof access hatch and, if necessary, the awning in good time..</p>

6.2 Commissioning

The following steps must be carried out before commissioning:

- Check the electrical connections.
- Correct installation of the roof access hatch.
- Check the movement of the opening sashes and, if necessary of the awning for degree of freedom.
- Check that the opening sashes are free from mechanical stresses.
- Check the function of the sensor. To do this

place an obstacle in the detection area. The drives must be stopped immediately or must not be started. They may only be restarted after the obstacle has been removed from the detection area!

Safety approval

After completion of the above-mentioned tests, a safety approval must be carried out. The inspector certifies compliance with all specifications for the installation and operation of the roof access hatch. If special conditions prevail at the installation site that may cause additional hazards than those specified in these operating instructions, the inspector will assess the adequacy of additional protective measures taken and the safety of operation.

The safety approval may only be carried out by qualified personnel (e.g. roofers, architects, fitters). The safety inspection report must be completed (see chapter 10). The safety approval refers to the function as a roof access hatch.

Handover ready for operation

After the functional and safety checks, the roof access hatch can be handed over ready for operation. This includes:

- Handover of the documents for safety approval
- Installation and operating instructions
- Instruction of the operator

6.3 Operation

Normal use

The roof access hatch can be operated using the push-button installed on site.

To do this:

- Make eye contact with the roof access hatch and assess the risk to third parties.
- Ensure that no objects are placed on the sash or frame
- Press the button function for the desired direction of travel (OPEN/CLOSE)

Note	
i	<p>The drives of the roof access hatch run as long as the button is pressed.</p> <p>If actuation ends, the drives stop immediately (dead-man operation). In contrast to the closing direction, the roof access hatch does not have a limit switch in the opening direction. This end position can be terminated acoustically by a change in the sound of the button.</p>

If an obstacle enters the detection range of the sensor, the drives stop immediately or do not start. In this case:

- Remove the obstacle and press the button again as described.

Optional: Operate awning with push-button:

- To open and close the awning, press the on-site push-button with OPEN and CLOSE
- Check whether the movement range of the awning is free of objects
- Assess the use of the awning according to environmental conditions (weather influences)

Warning	
	<p>Risk of injury!</p> <p>There is a risk of injury during operation due to restricted visibility caused by opaque glazing or awning.</p> <p>>> Check that the movement area is clear before operation</p> <p>>> Ensure that there are no persons in the movement area</p>

Note	
i	<p>The profiles are thermally separated. In unfavourable climatic conditions (e.g. high indoor humidity and low outdoor temperature), though, temporary condensation may form on the aluminium and glass surfaces. This does not constitute a defect. (See also DIN 4108 Condensation on surfaces).</p> <p>To avoid condensation, we recommend regular "shock ventilation" and sufficient heating of the rooms.</p>

Operation during installation:

Operation may only be carried out by a qualified electrician.

Warning	
	<p>Risk of injury!</p> <p>There is an increased risk of injury to third parties when opening and closing the roof access hatch in emergency mode, as the drives are operated without being monitored by the sensor.</p> <p>>> Only use emergency operation if there is a defect in the sensor and the roof access hatch must be operated to protect against material damage.</p> <p>>> Secure the travel area of the roof hatch with suitable means (e.g. barriers, etc.).</p> <p>>> Only operate the roof window with visual contact. If this is not possible call in a safety person.</p>

Danger	
	<p>Danger from electric current!</p> <p>The housing of the control unit must be opened to operate the emergency operating buttons. Live cables or components are not protected against access, there is a danger to life!</p> <p>>> Work on electrical equipment may only be carried out by a qualified electrician or by instructed persons under the direction and supervision of a qualified electrician in accordance with electrotechnical regulations.</p>

Proceed as follows to operate the roof access hatch:

- Secure the travel range of the roof access hatch with suitable means (blocking off, providing a safety person, etc.)
- Open the inspection hatch using the snap locks

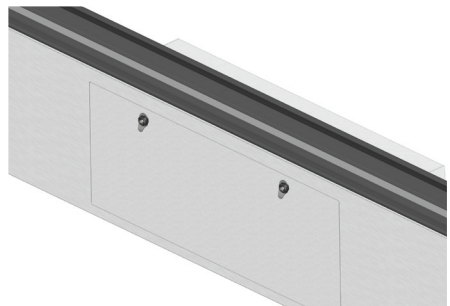

- Move the roof access hatch with the key on the switch cabinet.

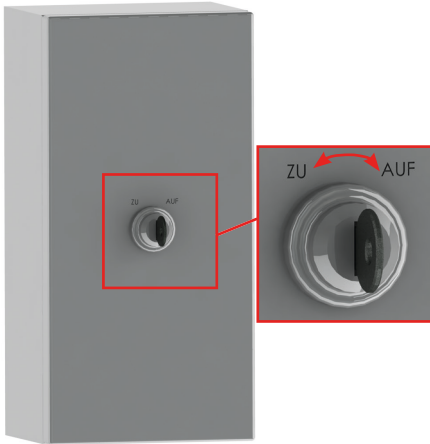

Manual operation in case of power failure or electrical defect:

In case of power failure or an electrical defect, the roof access hatch can be closed manually as follows:

- Open the inspection hatch

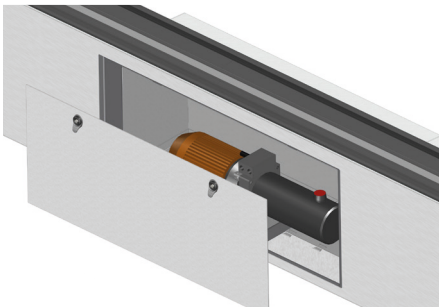

- Attach the enclosed handle
- Set the adjustment lever for the travel direction on the unit and hold it in the position:
 - to the rear = close
 - forwards = open

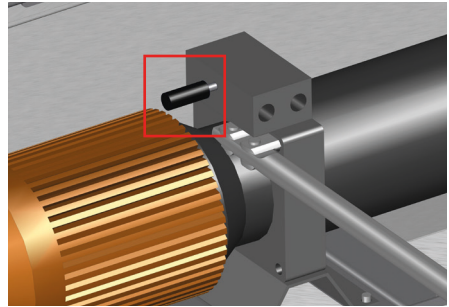

- unlock the locking mechanism before opening the access hatch

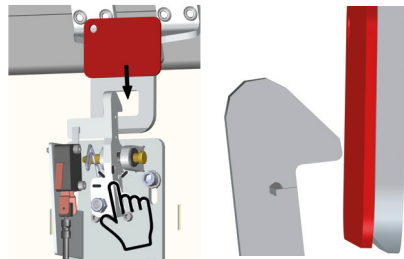
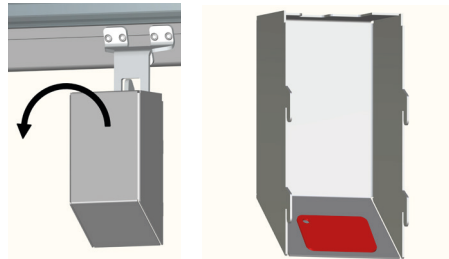

- Pump with the handle to move the sash

7. MAINTENANCE

7.1 Safety

Maintenance and care work may only be carried out by persons who:

- are authorized to do so due to their training and qualifications and qualified specialists.
- are authorized to do so by the operator of the roof access hatch.

Note	
i	Work on electrical equipment may only be carried out by a qualified electrician or by instructed persons under the direction and supervision of a qualified electrician in accordance with the electro-technical regulations!

- Carry out maintenance work in accordance with the operating instructions
- During maintenance work, secure the roof access hatch area and protect it against third parties
- Disconnect the control unit and secure it against being switched on again (put up a warning sign in accordance with VDE).

Danger	
	<p>Danger due to electric current!</p> <p>Contact with live cables or components can be fatal!</p> <p>>> Work on electrical equipment may only be carried out by a qualified electrician or by instructed persons under the direction and supervision of a qualified electrician in accordance with electrical engineering regulations.</p> <p>>> Before starting work, the safety rules of electrical engineering must be observed and applied.</p>

Warning	
	<p>Risk of injury due to insufficient qualification!</p> <p>During installation and maintenance, there is a risk of injury to the person carrying out the work due to working in the danger zone. Incorrect installation or maintenance can result in hazards for subsequent operation.</p> <p>>> Installation and maintenance work may only be carried out by qualified personnel.</p>

Warning	
	<p>Risk of injury!</p> <p>There is a risk of injury to third parties when opening and closing the roof access hatch.</p> <p>>> Only trained operators are permitted to operate the roof access hatch.</p> <p>>> When opening and closing, maintain visual contact with the roof access hatch to protect third parties from danger.</p>

Warning	
	<p>Risk of injury due to incorrect or missing protection equipment!</p> <p>Personal protection equipment must be worn during work in order to minimize health hazards.</p> <p>>> Always wear the protection equipment required for the respective work while working.</p> <p>>> Follow the instructions on personal protection equipment displayed in the work area.</p>

	<p>Harness for fall protection</p>
---	------------------------------------

Warning	
	<p>Danger of falling!</p> <p>There is a considerable risk of injury and even death from falling at the roof access hatch and on the roof edges.</p> <p>>> Do not step on the edges</p> <p>>> Block off danger zones</p> <p>>> Wear personal protection equipment</p>

Warning	
	<p>Risk of crushing!</p> <p>There is a risk of injury when opening and closing the roof access hatch.</p> <p>>> Do not stand in the exit area when opening and closing the device.</p> <p>>> Do not reach into the moving parts.</p> <p>>> During maintenance work, secure the roof access hatch area and block it off from third parties.</p> <p>>> Disconnect the control unit and secure it against being switched on again (put up a warning sign in accordance with VDE).</p>

After each maintenance

- Check safety equipment.
- Check that the roof access hatch is functioning properly.

7.2 Maintenance

Regular maintenance is required to ensure that the roof access hatch and its components function properly.

Carry out maintenance in accordance with the maintenance schedule. If damage to the roof access hatch, the components or functional limitations are detected during maintenance:

- Put the roof access hatch out of operation.
- Initiate repair immediately

Attention	
	<p>Material damage!</p> <p>If defects or functional restrictions are detected, further operation may result in considerable damage to the roof access hatch.</p> <p>>> In case of defects or functional restrictions, do not use the roof access hatch and put it out of operation.</p> <p>>> Initiate repair immediately.</p>

Maintenance schedule

Interval *	Maintenance work
Min. 1x per year	Visual inspection of the roof access hatch and all components
	General functional check
	Functional check of the safety device (sensor)
	Check the function of the key switch on the control cabinet (chapter: Operation)
	Check the ease of movement of the linear guides of the opening sashes and lubricate if necessary. Only use acid-free grease for lubrication.
	Lightly oil the moving parts regularly to prevent impairing their functionality. Only use acid-free oil.
	Rub the circumferential lip seal with talcum powder to maintain the suppleness of the rubber and prevent it from freezing in winter.
	Have hydraulic components serviced by a technician.

* The specified maintenance intervals are a recommendation!

The interval times depend on the prevailing environmental influences (e.g. humidity, temperature).

	Note
i	<p>The profiles are thermally separated. However, in unfavorable climatic conditions (e.g. high indoor humidity and low outdoor temperature), temporary condensation may form on the aluminium and glass surfaces. This does not constitute a defect. (See also DIN 4108 Condensation on surfaces).</p> <p>To avoid condensation, we recommend regular "shock ventilation" and sufficient heating of the rooms.</p>

7.3 Repairs

	Warning
	<p>Risk of injury!</p> <p>Incorrect or faulty spare parts can lead to damage, malfunctions or total failure of the machine and endanger safety.</p> <p>>> Only use original spare parts from the manufacturer.</p>

Repairs to the roof access hatch may only be carried out by authorized specialist companies.

	Note
i	<p>LAMILUX Heinrich Strunz GmbH customer service is available to answer any questions regarding repairs.</p>

7.4 Cleaning

The roof access hatch must be cleaned regularly (depending on the degree of soiling).

	Attention
	<p>Material damage!</p> <p>Improper cleaning and unauthorized cleaning agents can damage the roof access hatch.</p> <p>>> Never use chemical cleaning agents or solvents.</p> <p>>> Follow the cleaning instructions.</p>

- Clean the glass surfaces with standard detergents and glass cleaners
- Only clean the painted surfaces using mild detergents and a soft sponge with sufficient water

8. TROUBLESHOOTING

8.1 Safety

Danger	
	<p>Danger due to electric current!</p> <p>Contact with live cables or components can be fatal!</p> <p>>> Work on electrical equipment may only be carried out by a qualified electrician or by instructed persons under the direction and supervision of a qualified electrician in accordance with electrical engineering regulations.</p> <p>>> Before starting work, the safety rules of electrical engineering must be observed and applied.</p>

Warning	
	<p>Risk of crushing!</p> <p>There is a risk of injury when opening and closing the roof access hatch.</p> <p>>> Do not stand in the exit area when opening and closing the device.</p> <p>>> Do not reach into the moving parts.</p>

Warning	
	<p>Risk of injury due to insufficient qualification!</p> <p>When working on the roof access hatch, there is a risk of injury to the person carrying out the work due to working in the danger zone. Incorrect work can result in hazards for subsequent operation.</p> <p>>> Work on the roof access hatch may only be carried out by specialised personnel.</p>

Warning	
	<p>Danger of falling!</p> <p>There is a considerable risk of injury and even death from falling at the roof access hatch and on the roof edges.</p> <p>>> Do not step on the edges</p> <p>>> Block off danger zones</p> <p>>> Wear personal protection equipment</p>

Warning	
	<p>Risk of injury due to incorrect or missing protection equipment!</p> <p>Personal protection equipment must be worn during work in order to minimize health hazards.</p> <p>>> Always wear the protection equipment required for the respective work while working.</p> <p>>> Follow the instructions on personal protection equipment displayed in the work area.</p>

8.2 Malfunctions and troubleshooting

The following table is supposed to help determine the cause of a malfunction and to be able to initiate a repair.

Defect	possible cause	Troubleshooting
Roof access hatch does not move	Voltage supply interrupted	Check power supply and, if necessary restore
	Obstacle in the detection range of the sensor	Remove obstacle and operate the roof access hatch again
	Sensor defect	If necessary, close the roof access hatch as described in the „Operation“ chapter. Take the roof access hatch out of operation and initiate repair.

If the points listed do not fix the fault, then:

- Block the roof access hatch for manual operation
- Initiate repair

9. DISMANTLING AND DISPOSAL

9.1 Safety

Danger	
	<p>Danger due to electric current! Contact with live cables or components can be fatal! >> Work on electrical equipment may only be carried out by a qualified electrician or by instructed persons under the direction and supervision of a qualified electrician in accordance with electrical engineering regulations. >> Before starting work, the safety rules of electrical engineering must be observed and applied.</p>

Warning	
	<p>Risk of injury due to insufficient qualification! During installation and maintenance, there is a risk of injury to the person carrying out the work due to working in the danger zone. Incorrect installation or maintenance can result in hazards for subsequent operation. >> Installation and maintenance work may only be carried out by qualified personnel.</p>

Warning	
	<p>Risk of crushing! There is a risk of injury when opening and closing the roof access hatch. >> Do not stand in the exit area when opening and closing the device. >> Do not reach into the moving parts.</p>

Warning	
	<p>Danger of falling! There is a considerable risk of injury and even death from falling at the roof access hatch and on the roof edges. >> Do not step on the edges >> Block off danger zones >> Wear personal protection equipment</p>

Warning	
	<p>Risk of injury due to incorrect or missing protection equipment!</p> <p>Personal protection equipment must be worn during work in order to minimize health hazards.</p> <p>>> Always wear the protection equipment required for the respective work while working.</p> <p>>> Follow the instructions on personal protection equipment displayed in the work area.</p>

Attention	
	<p>Environmental damage due to incorrect disposal!</p> <p>Incorrect disposal can lead to environmental damage.</p> <p>>> Electrical waste, electronic components, lubricants and other auxiliary materials are subject to hazardous waste treatment and may only be disposed of by authorized specialist companies</p>

Note	
	<p>The local municipal authority or specialist disposal companies can provide information on environmentally friendly disposal.</p>

9.2 Dismantling

To dismantle the roof access hatch:

- Ensure that there is no voltage (mains and battery voltage)
- Disconnect electrical connections
- Dismantle the roof access hatch
- Remove the roof access hatch

9.3 Disposal

If no take-back or disposal agreement has been made, disassembled components must be recycled:

- Scrap metal.
- Give plastic elements to recycling
- Dispose of other components sorted by material properties .

10. COMMISSIONING PROTOCOL

The LAMILUX Flat Roof Access Hatch Comfort Swing/Square may only be released for use after passing the approval test, for which the following requirements must be met:

- All tests in accordance with the section "Results of the tests carried out" must be carried out by qualified personnel;
- All queries in the section "Results of the tests carried out" must be answered with "YES" or a meaningful description;
- This form must be completed in full and signed.

Use must be effectively prevented before this commissioning test. The test must be documented on this form and handed over to the operator as part of the system documentation. The commissioning test relates exclusively to the roof exit function and must be carried out in addition to other prescribed tests. A qualified person is a person who is suitable to carry out the testing tasks due to their qualifications, experience and professional activity. The necessary qualification includes, in particular, sufficient electrotechnical training and appropriate work experience to ensure professional installation of all safety-relevant parts.

If you are unsure about safety measures, installation details or the parts required for the installation of the roof access hatch, please contact LAMILUX. You will find our address under point 1.9 "Manufacturer's address" in these operating instructions.

Operator of the system	Name:	
	Address:	
	Phone:	Mail:
Inspector	Name:	
	Address:	
	Phone:	Mail:
Installation information	Address:	
	Exact location:	
	LAMILUX order number:	



Follow all local rules and regulations applicable to this product. Failure to do so may result in serious injury or death

Results of the test carried out	Tick as appropriate:		Description*
	YES	NO	
Operation is only possible via key switch in the visible area of the roof access hatch (or via emergency button in emergency operation).			
The key switch is not self-holding.			
The sensor is functional.			
The limit switch is set correctly.			
The installation is without automatic actuation (smart home controls, wind/rain sensor etc. are NOT permitted!) Exception: Emergency operation.			
The warning notices are properly attached to the roof access hatch.			
The roof access hatch is the only access to the roof.**			

*It is possible that neither "Yes" nor "No" is applicable, as the operator still has to fulfill the respective point in a later construction phase and this point is therefore no longer part of this safety check. This must be noted by the inspector and the responsibility for fulfilling the requirement is transferred to the operator.

**If there are several access points to the roof, suitable measures must be taken to ensure that no persons can remain in the danger zone during operation.

Declaration by the inspector

The commissioning test was carried out in full and all questions in the "Results of the tests carried out" section of the table were answered truthfully with "YES" or a reason was given. Furthermore, I am not aware of any other circumstances that could cause a deviation from the intended use described in the documentation (see operating instructions) now or in the future or that could impair the operational safety of the roof access hatch in any other way.

	Place, Date:
	Signature inspector:
	Signature operator:

To ensure safe operation of the roof access hatch, the following points must also be fulfilled:

- The stairs and steps to the roof are properly designed, built and installed in accordance with local rules and regulations.
- The safety distances on the roof comply with local regulations (see chapter 4.3 Installation operating instructions).
- A handrail should be attached to the roof access hatch depending on the design of the stairs.
- The danger area of the roof access hatch is sufficiently illuminated.
- There is a railing around the roof access hatch. The design of the railing on the roof ensures both fall protection and anti-trap protection.

11. DECLARATION OF CONFORMITY

Deutsch / English

LAMILUX Heinrich Strunz GmbH
Zehstraße 2
D-95111 Rehau
GERMANY



Konformitätserklärung / Declaration of Conformity

Hiermit erklären wir, dass das nachstehend bezeichneten Produkte in seiner Konzeption und Bauart sowie in der von uns in Verkehr gebrachten Ausführung den grundlegenden Sicherheits- und Gesundheitsanforderungen der unten aufgeführten Verordnungen und Richtlinien entsprechen. Bei einer mit uns nicht abgestimmten Änderung des Produktes verliert dies. Die alleinige Verantwortung für die Ausstellung dieser Konformitätserklärung trägt der Hersteller.

Hereby we declare that the products described below are in its conception and Design as well as in the execution we put on the market the basic Safety and health requirements of the regulations and directives listed below. In case of a change of the product not agreed with us, this loses. The sole responsibility for the issuance of this Declaration of Conformity lies with the manufacturer.

PRODUKTE / PRODUCTS

Produktart / product type : Dachausstieg / Roof Exit
Produktbaureihe / product series : LAMILUX Flachdach Ausstieg Komfort Swing / LAMILUX Flat Roof Exit Comfort Swing
Datum / date : 25.10.2019

VERORDNUNGEN UND RICHTLINIEN / REGULATIONS AND DIRECTIVES:

Maschinenrichtlinie 2006/42/EU – Machinery Directive 2006/42/EU

Niederspannungsrichtlinie 2014/35/EU - Low Voltage Directive 2014/35/EU

Richtlinie über elektromagnetische Verträglichkeit 2014/30/EU - Directive relating to Electro-Magnetic Compatibility 2014/30/EU

HARMONISIERTE NORMEN / HARMONIZED STANDARDS:

- DIN EN 12978: **Türen und Tore - Schutzeinrichtungen für kraftbetätigte Türen und Tore - Anforderungen und Prüfverfahren** Industrial, commercial and garage doors and gates - Safety devices for power operated doors and gates - Requirements and test methods
- DIN EN 60335-1: **Sicherheit elektrischer Geräte für den Hausgebrauch und ähnliche Zwecke - Teil 1: Allgemeine Anforderungen** - Household and similar electrical appliances - Safety - Part 1: General requirements
- DIN EN 60335-2-103: **Sicherheit elektrischer Geräte für den Hausgebrauch und ähnliche Zwecke - Teil 2-103: Besondere Anforderungen für Antriebe für Tore, Türen und Fenster** - Household and similar electrical appliances - Safety - Part 2-103: Particular requirements for drives for gates, doors and windows
- DIN EN ISO 14120: **Sicherheit von Maschinen - Trennende Schutzeinrichtungen - Allgemeine Anforderungen an Gestaltung und Bau von feststehenden und beweglichen trennenden Schutzeinrichtungen** - Safety of machinery - Guards - General requirements for the design and construction of fixed and movable guards
- DIN EN ISO 12100: **Sicherheit von Maschinen - Allgemeine Gestaltungsleitsätze - Risikobeurteilung und Risikominderung** - Safety of machinery - General principles for design - Risk assessment and risk reduction
- DIN EN ISO 13849-1: **Sicherheit von Maschinen - Sicherheitsbezogene Teile von Steuerungen - Teil 1: Allgemeine Gestaltungsleitsätze** - Safety of machinery - Safety-related parts of control systems - Part 1: General principles for design
- DIN EN ISO 13849-2: **Sicherheit von Maschinen - Sicherheitsbezogene Teile von Steuerungen - Teil 2: Validierung** - Safety of machinery - Safety-related parts of control systems - Part 2: Validation
- DIN EN ISO 13850: **Sicherheit von Maschinen - Not-Halt-Funktion - Gestaltungsleitsätze** - Safety of machinery - Emergency stop function - Principles for design

Rehau, 25.10.2019

ppa. Dipl. Ing. Joachim Hessemer
Technischer Leiter / technical director



-
- DIN EN ISO 13855: **Sicherheit von Maschinen - Anordnung von Schutzvorrichtungen im Hinblick auf Annäherungsgeschwindigkeiten von Körperteilen** - *Safety of machinery - Positioning of safeguards with respect to the approach speeds of parts of the human body*
 - DIN EN ISO 13857: **Sicherheit von Maschinen - Sicherheitsabstände gegen das Erreichen von Gefährdungsbereichen mit den oberen und unteren Gliedmaßen** - *Safety of machinery - Safety distances to prevent hazard zones being reached by upper and lower limbs*
 - DIN EN 60204-1: **Sicherheit von Maschinen - Elektrische Ausrüstung von Maschinen - Teil 1: Allgemeine Anforderungen** - *Safety of machinery - Electrical equipment of machines - Part 1: General requirements*
 - ProdSG: **Produktsicherheitsgesetz** - *Product Safety Act*
 - DIN EN 61439-2: **Niederspannungs-Schaltgerätekombinationen - Teil 2: Energie-Schaltgerätekombinationen** - *Low-voltage switchgear and controlgear assemblies - Part 2: Power switchgear and controlgear assemblies*
 - DIN EN 61439-3: **Niederspannungs-Schaltgerätekombinationen - Teil 3: Installationsverteiler für die Bedienung durch Laien (DBO)** - *Low-voltage switchgear and controlgear assemblies - Part 3: Distribution boards intended to be operated by ordinary persons (DBO)*
-

SONSTIGE TECHNISCHE NORMEN UND SPEZIFIKATIONEN / FURTHER TECHNICAL STANDARDS AND SPECIFICATIONS:

Montageanweisung / *Installation instructions*

Sicherheitshinweise / *safety instructions*



12. NOTES

12. NOTES



Scan this to discover more about
LAMILUX daylight systems!



ROOFLIGHT F100



GLASS SKYLIGHT F100



GLASS SKYLIGHT FE



GLASS ARCHITECTURE



RENOVATION



MIROTEC STEEL CONSTRUCTIONS



CONTINUOUS ROOFLIGHT B



CONTINUOUS ROOFLIGHT S



CONTINUOUS ROOFLIGHT W|R



SMOKE AND HEAT EXHAUST
VENTILATION SYSTEMS



BUILDING CONTROL SYSTEMS



RODA LIGHT AND
AIR TECHNOLOGY

The technical data printed in this brochure was accurate when this brochure went to press and is subject to change without notice. Our technical specifications are based on calculations and supplier specifications, or have been determined by independent testing authorities within the scope of applicable standards.

Thermal transmission coefficients for our composite glazing were calculated using the finite element method with reference values in accordance with DIN EN 673 for insulated glass. Based on empirical values and specific characteristics of the plastics, a temperature vector of 15 K was defined as the vector between the outer surfaces of the material. Functional values refer to test specimens and the dimensions used in testing only. We cannot provide any further guarantees of technical values. This particularly applies to changes in installation locations, or if dimensions are re-measured on site.



LAMILUX Heinrich Strunz GmbH

Zehstraße 2 · PO Box 1540 · 95111 Rehau · Tel.: +49 (0) 92 83 / 5 95-0 · Fax +49 (0) 92 83 / 5 95-29 0

E-Mail: information@lamilux.de · www.lamilux.com

